

CLS : CLOSE LIMIT SWITCH (250VAC 10A)
 OLS : OPEN LIMIT SWITCH (250VAC 10A)
 CTS : CLOSE TORQUE SWITCH (250VAC 10A)
 OTS : OPEN TORQUE SWITCH (250VAC 10A)
 ACLS : AUX. CLOSE LIMIT SWITCH (250VAC 10A)
 AOLS : AUX. OPEN LIMIT SWITCH (250VAC 10A)
 TP : THERMAL PROTECTOR (250VAC 15A OPTION)
 *EACH ACTUATOR SHOULD BE POWERED THROUGH ITS OWN INDIVIDUAL SWITCH OR RELAY CONTACTS TO PREVENT CROSS FEED BETWEEN TWO OR MORE ACTUATORS.

TORQUE AND LIMIT SWITCHES OPERATION			
SWITCH	CLOSE ←	INTERMEDIATE	→ OPEN
CLS 1-2			
CLS 1-3			
OLS 1-2			
OLS 1-3			
ACLS 1-3			
AOLS 1-3			
CTS 1-3	* CLOSING TORQUE SWITCH INTERRUPTS CONTROL IF MECHANICAL OVERLOAD OCCURS DURING CLOSING CYCLE		
OTS 1-3	* OPENING TORQUE SWITCH INTERRUPTS CONTROL IF MECHANICAL OVERLOAD OCCURS DURING OPENING CYCLE		

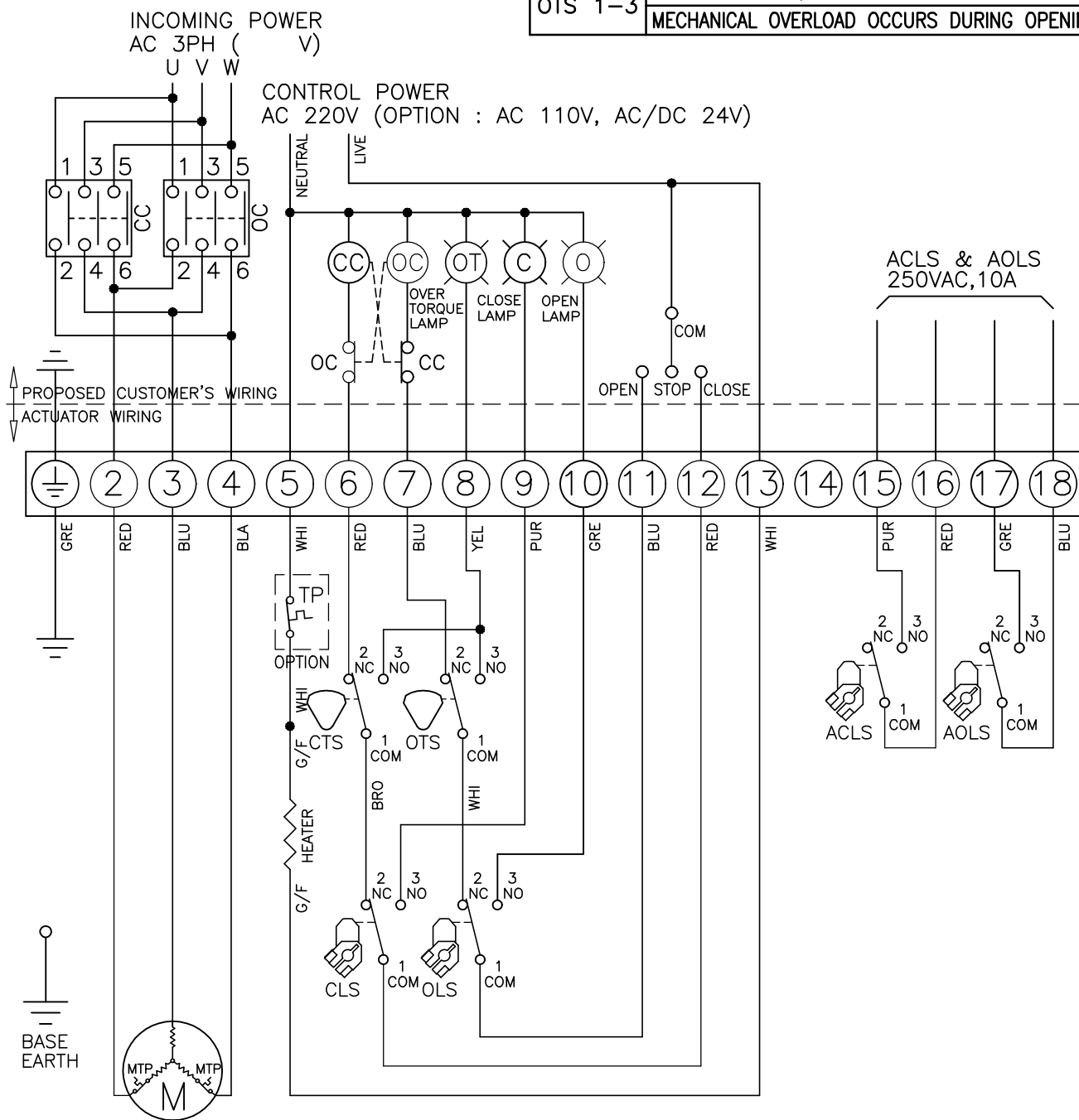

ITQ-3000	
ITQ-2000	
ITQ-1100	
ITQ-0800	
ITQ-0500	
ITQ-0350	
ITQ-0240	
ITQ-0160	ITQ-9000
APP'L,FILE	ITQ-6000

i-tork CONTROLS
<http://www.i-tork.com>

PART NAME
3PH WIRING DIAGRAM

OPTION NAME
STANDARD

DRAWN	DESIGN	CHECKED	APPROVER
C.S.CHO			C.S.CHO
ISSU. DEPT.	DATE	SIZE	PROGRAM
ITCDR	2016.10.01	A4	AUTOCAD LT 2010
WIR No.			
ITQ0160-80000-F			